

# TnT speeltoestellen

## Montagehandleiding

### 3do-481

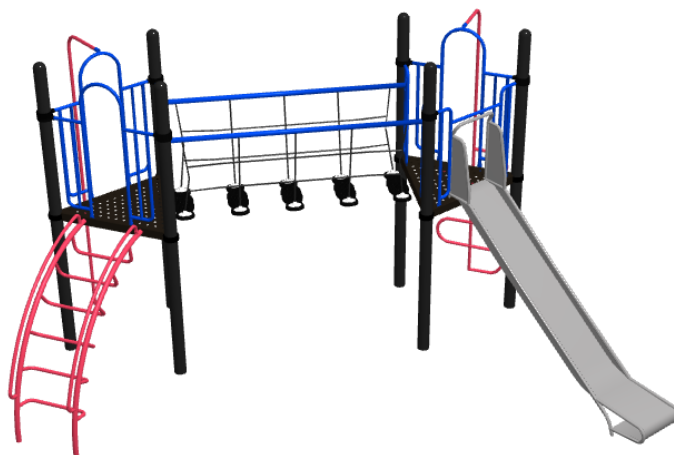

---

Toestel	3do-481
Datum montagehandleiding	04-04-2022

---

Beste klant van TnT Speeltoestellen,

Wij danken u voor het aanschaffen en installeren van een speeltoestel van TnT Speeltoestellen.

Wij waarderen het vertrouwen dat u in ons bedrijf heeft geplaatst en streven ernaar om uw vertrouwen meer dan waar te maken!

Dit is uw TnT speeltoestellen montagehandleiding.

Wij hebben deze handleiding specifiek voor het product ontworpen, waarop eveneens de toe te passen onderdelen zijn genoemd.

Ook vindt u het grondplan met de benodigde valruimte volgens norm NEN-EN1176-1 : 2017.

Bewaart u dit document bij uw logboek. Nogmaals willen wij u bedanken voor de aankoop van dit speeltoestel. Wij zien uit naar uw volgende speelproject.

Met vriendelijke groet, TnT Speeltoestellen

## Inhoudsopgave

Aanzichten 3D	2
Onderdelenlijst	3
Veiligheidsruimtes	4
Zijaanzichten	5
Plattegrond palenplan	6
Onderdeel handleidingen	8
Staander 350cm	9
Vloer gelijke driehoek (vloer_driehoek_gelijk)	11
Stappenbrug lang (brug_stappen_lang)	14
Half ronde opgang (klimrek_150cm_boog)	20
Glijstang (glijstang_150cm)	24
Opgang slang (b-klimmer_150cm)	28
Glijbaan RVS (glijbaan_150cm_metaal)	32

## Aanzichten 3D

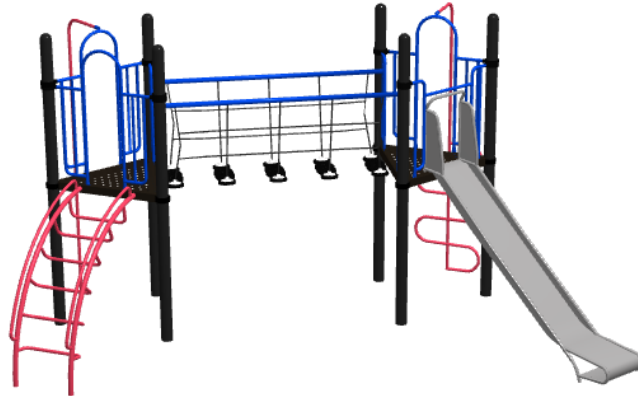

Aanzicht 1

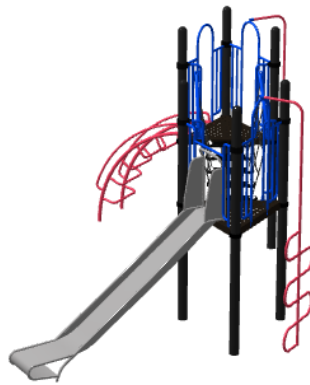



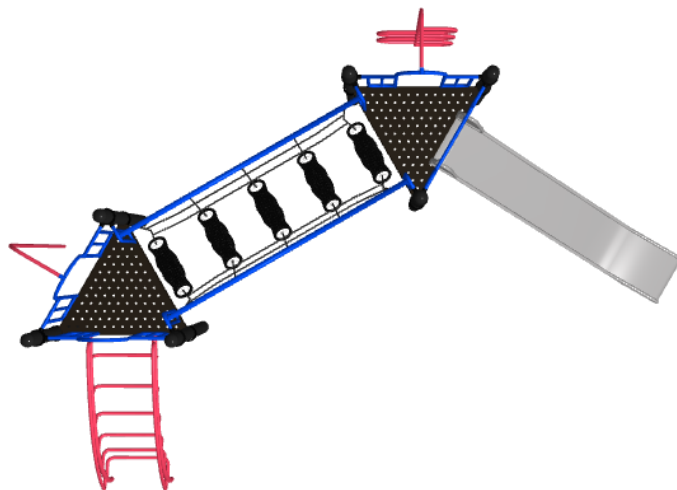

Aanzicht 2

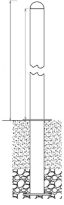
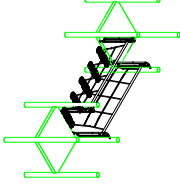
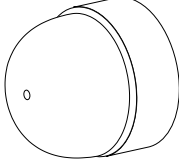
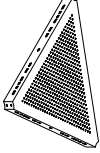
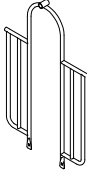

Aanzicht 3

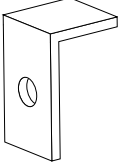
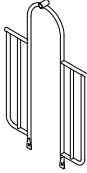
## Onderdelenlijst

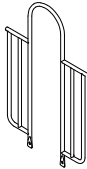
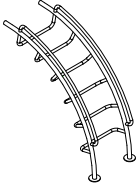
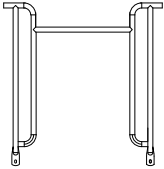
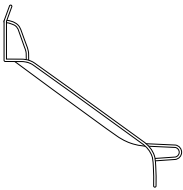
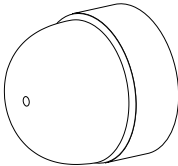
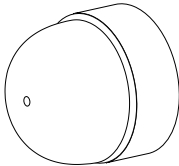
<p><b>6x</b> Staander 350cm</p> <p>350x11,5cm</p> 	<p><b>1x</b> 5-Stappenbrug</p> <p>233x105x100cm</p> 	<p><b>50x</b> Afdekdop M10</p> <p>M10</p> 	<p><b>2x</b> Driehoeksvloer 116,5x116,5x116,5cm</p> <p>117x117x117cm</p> 
<p><b>1x</b> Hekje tbv glijstang</p> <p>152x101cm</p> 	<p><b>1x</b> 150cm Glijstang</p> <p>362x42cm</p> 	<p><b>2x</b> Hoekje</p> 	<p><b>1x</b> Hekje tbv: B, Pod en Curly Climber</p> <p>152x101cm</p> 
<p><b>1x</b> 150cm B climber</p> <p>362x44cm</p> 	<p><b>1x</b> Hekje zonder bevestiging (boven)</p> <p>152x101cm</p> 	<p><b>1x</b> 150cm Arch climber</p> <p>217x150x73cm</p> 	<p><b>1x</b> Hek voor RVS glijbaan</p> <p>104x101cm</p> 
<p><b>1x</b> RVS Glijbaan 150cm</p> <p>250x221cm</p> 	<p><b>4x</b> Afdekdop M6</p> <p>M6</p> 	<p><b>2x</b> Afdekdop M12</p> <p>M12</p> 	

# Veiligheidsruimtes

Geachte klant,

Zorg er altijd voor dat alle veiligheidsruimtes zoals aangegeven in ieder geval gehaald worden, dit zijn de minimale vereiste ruimtes voor een veilig gebruik van het speeltoestel.

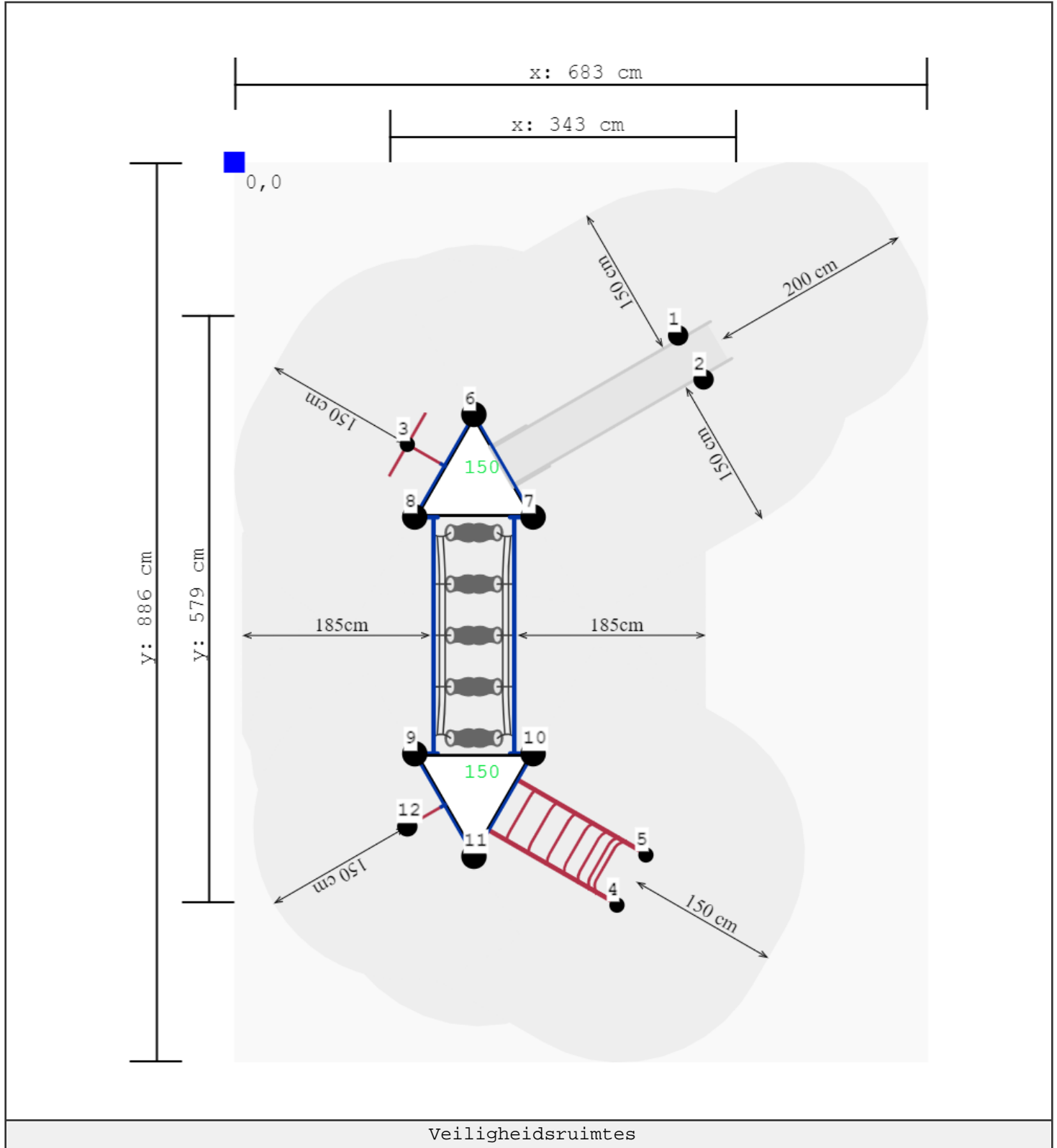

## Zijaanzichten

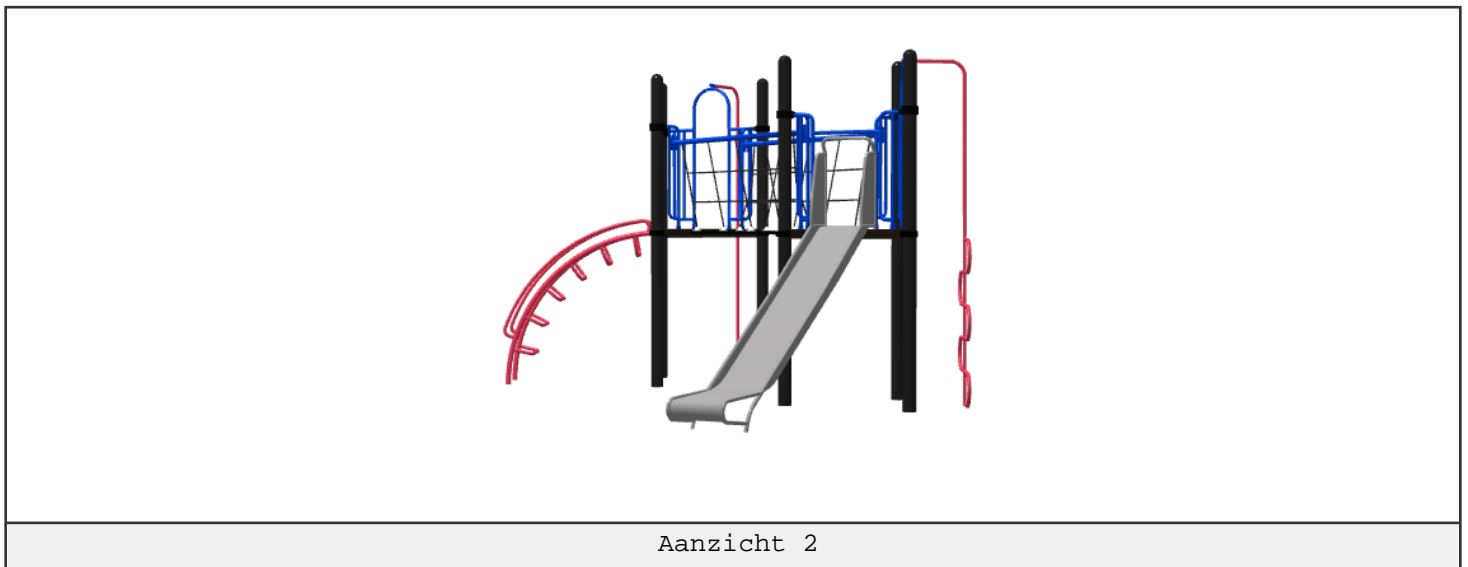
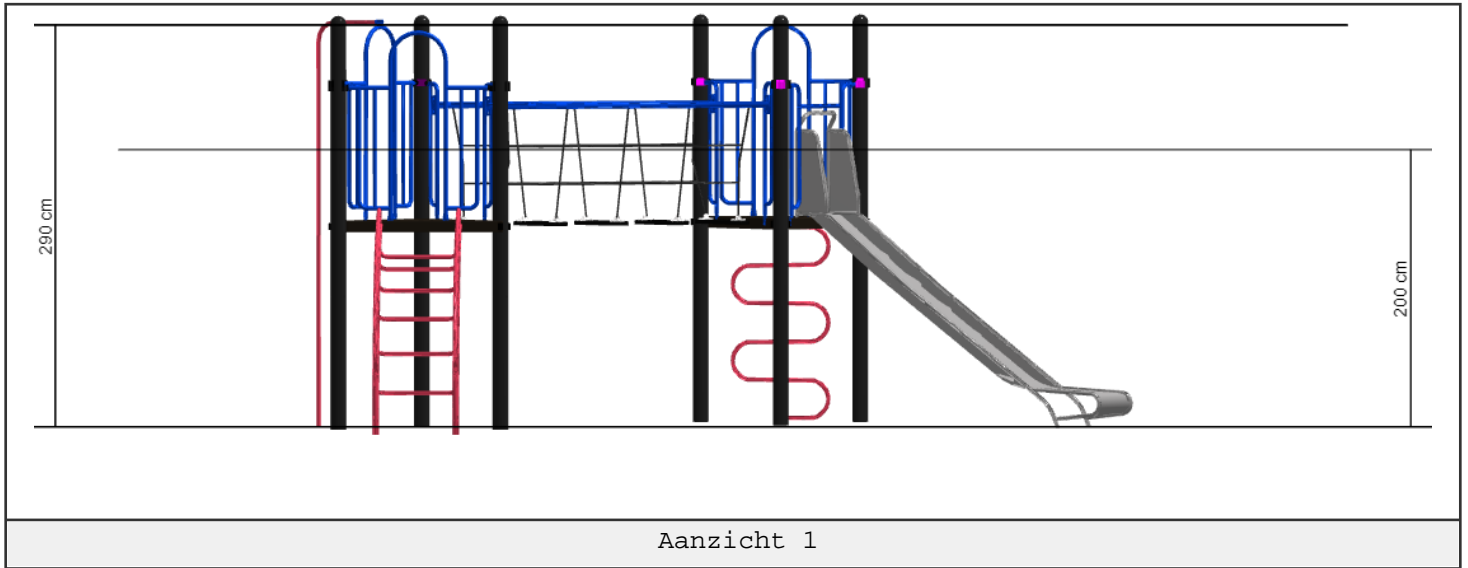

## Plattegrond palenplan

U kunt van deze tekening niet afmeten!

Voor de betonfundatie heeft u 37,5 kg snelbeton per staander nodig.

Voor de overige onderdelen (Glijstangen, Climbers, Glijbaan voeten) 25 kg snelbeton.

Houdt u er rekening mee dat de betonfundatie minimaal 400mm onder het maaiveld blijft, zoals op de tekening afgebeeld.

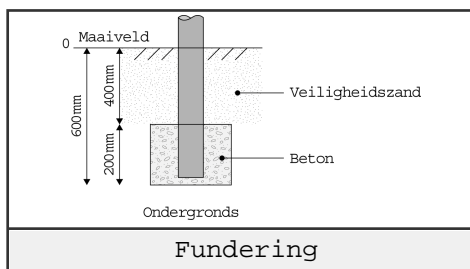
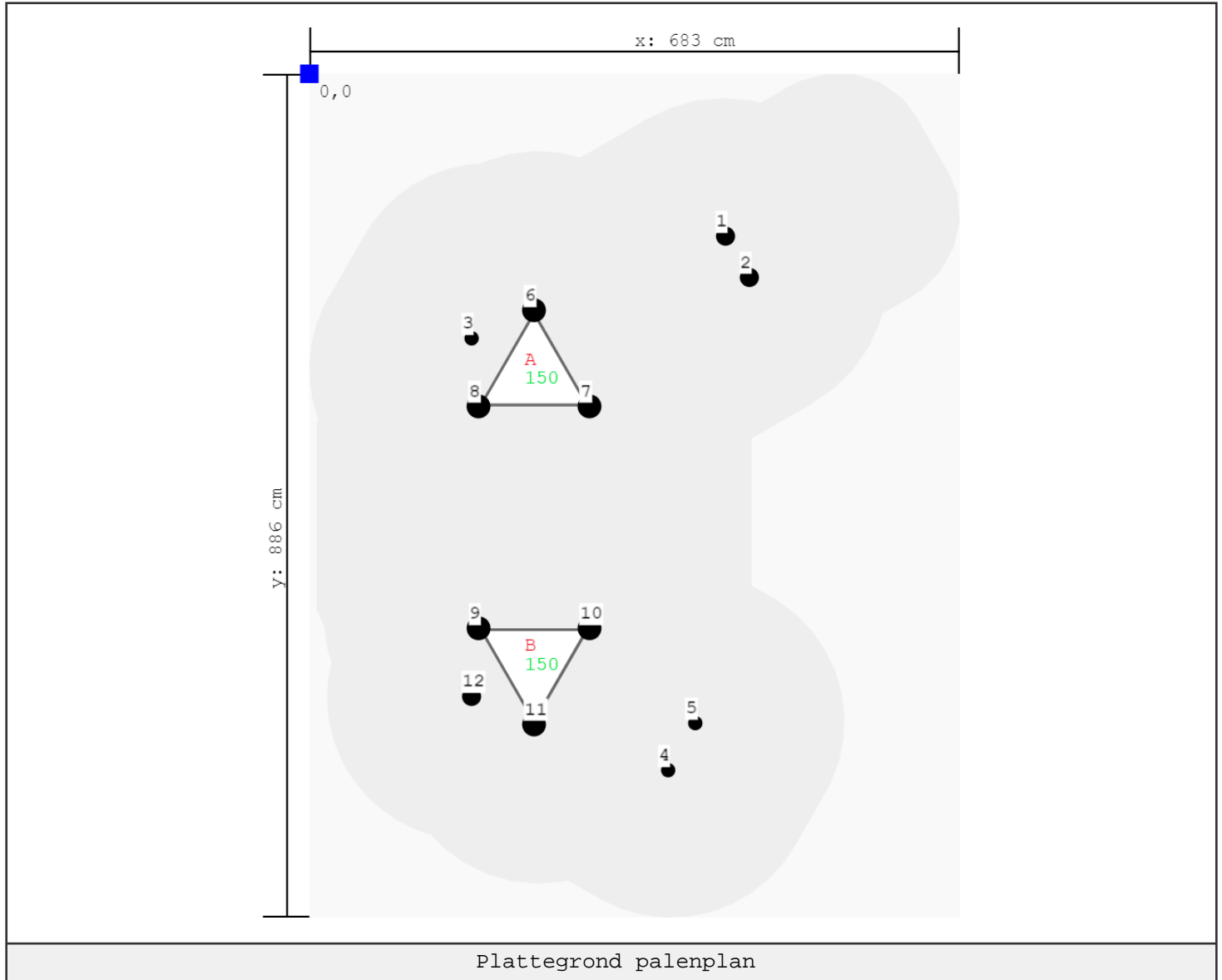

### Staanders

Label	X (cm)	Y (cm)	Hoogte
1	437	171	0 cm
2	462	214	0 cm
3	171	278	0 cm
4	377	731	0 cm
5	406	682	0 cm
6	236	249	350 cm
7	294	350	350 cm
8	178	350	350 cm
9	178	583	350 cm
10	295	583	350 cm
11	236	684	350 cm
12	171	654	0 cm

### Vloeren

Label	Hoogte
A	150 cm
B	150 cm



---

## Onderdeel handleidingen

Op de volgende pagina's van dit document vindt u alle individuele onderdelen met bijbehorende technische tekeningen en eventuele montage instructies.

# Stander 350cm

Hoofdafmetingen: 350x11,5cm

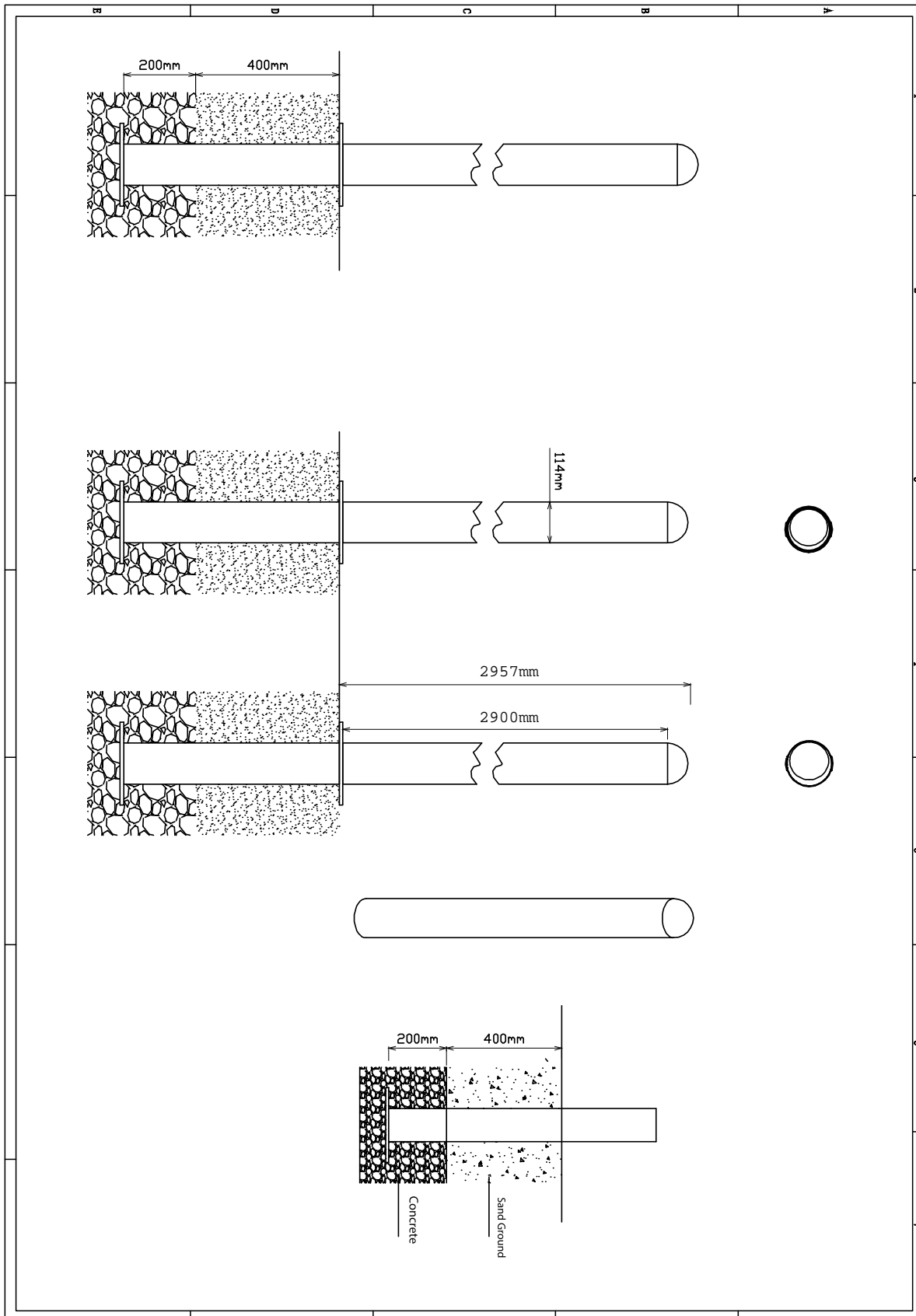



# Staander

STAP 1 van 1

Omschrijving: Paalkap losdraaien en opnieuw bevestigen met loctite op het draadeind

1 st. Loctite

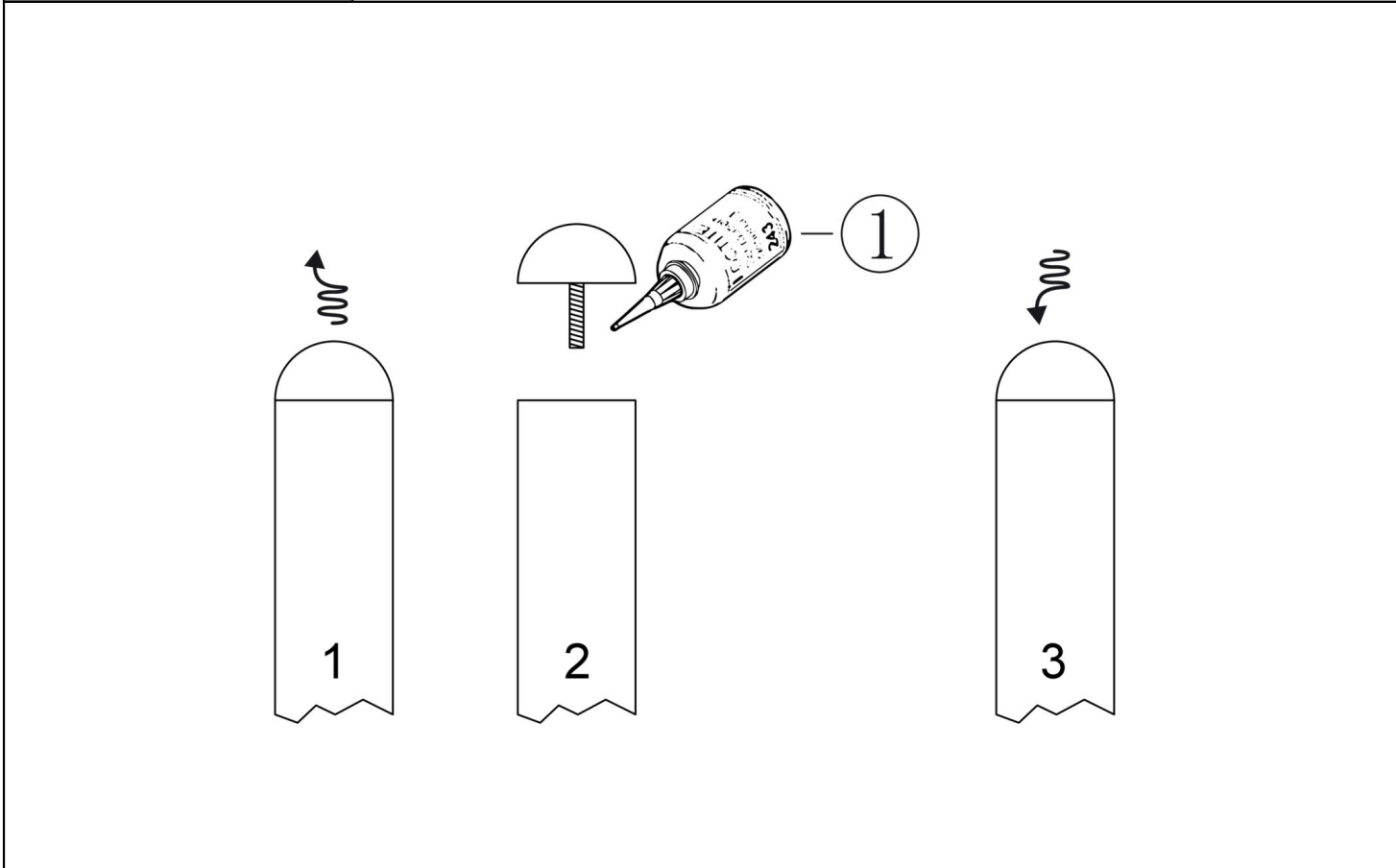
1



Bevestigings materiaal is per zakje verpakt en bovenstaande afbeelding zit in het zakje

# Driehoeksvloer 116,5×116,5×116,5cm

Hoofdafmetingen: 117x117x117cm

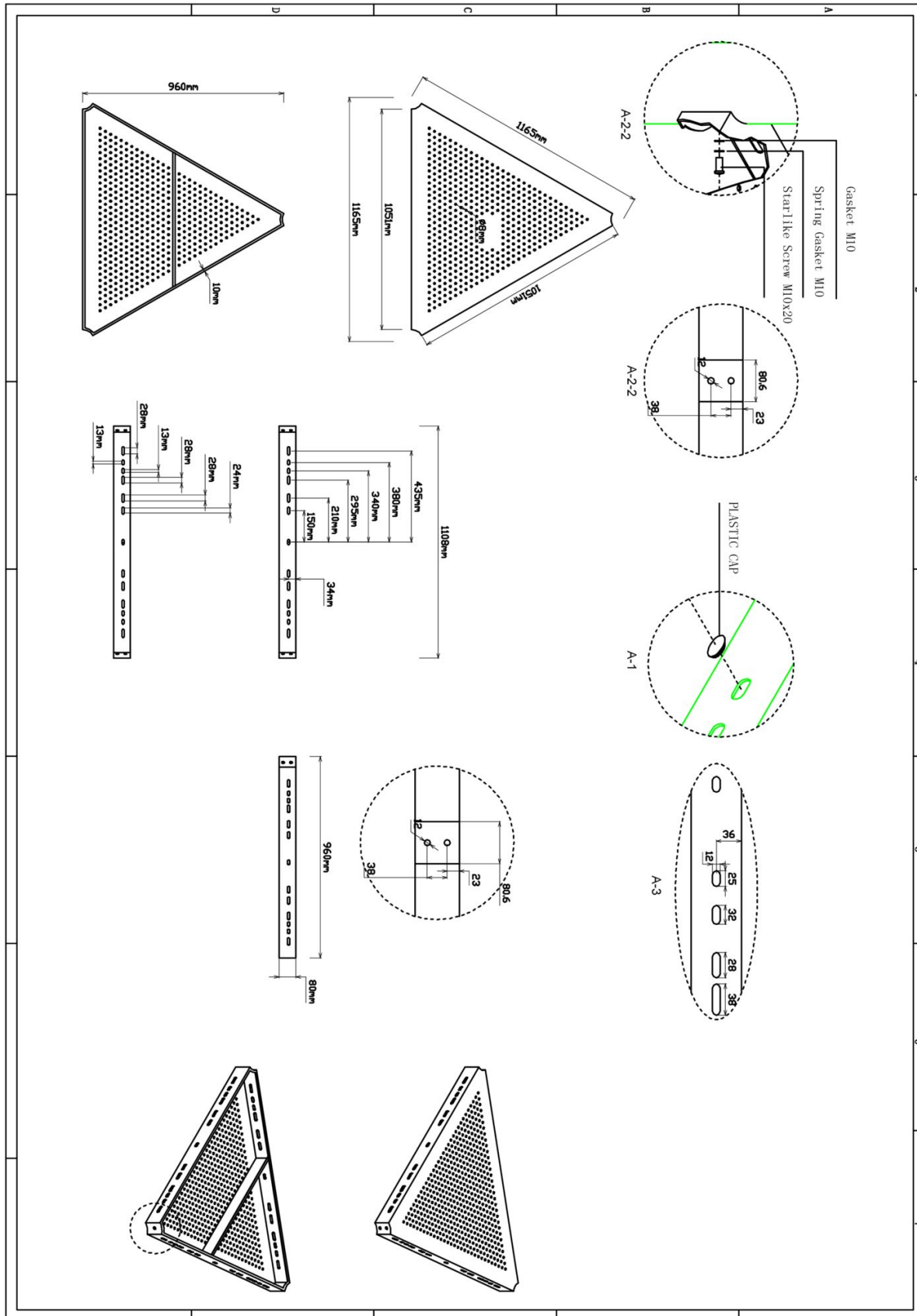

## Driehoeksvloer 116,5×116,5×116,5cm

STAP 1 van 2

Omschrijving: Bevestiging tussen de vloer en staander

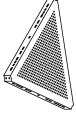
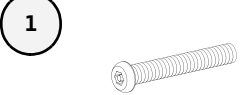
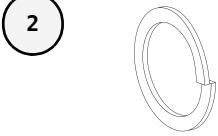
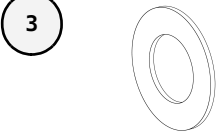
1 st. Driehoeksvloer 116,5×116,5×116,5cm	3 st. Torx M10X30	3 st. Veerring M10	3 st. Ring M10 (middel)
			

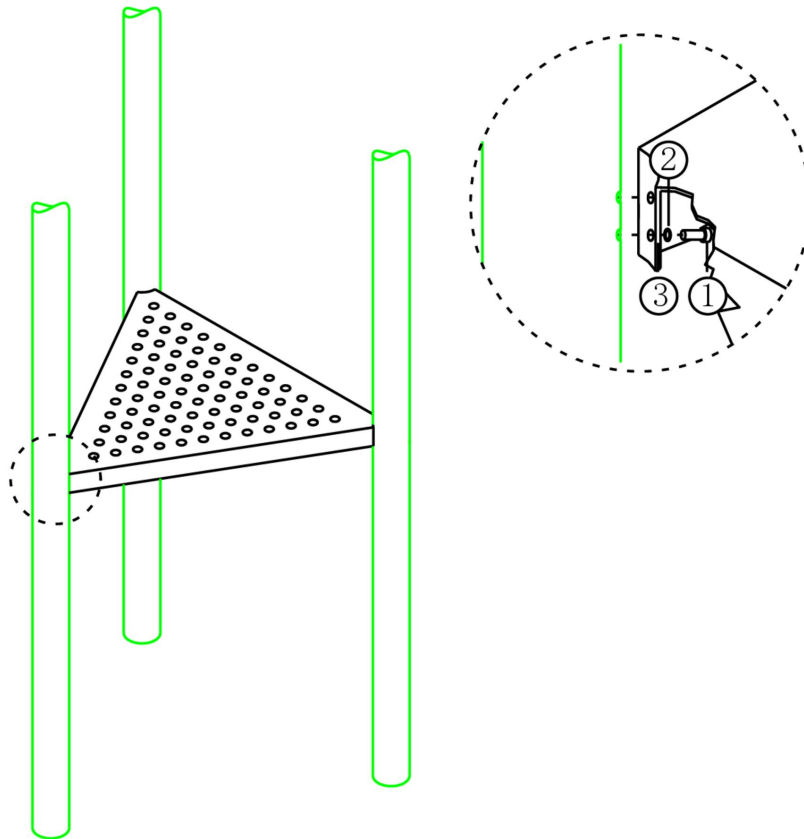

Bevestigings materiaal is per zakje verpakt en bovenstaande afbeelding zit in het zakje

## Driehoeksvloer 116,5×116,5×116,5cm

STAP 2 van 2

**Omschrijving:** De strips op lengte maken met de slijptol of kniptang. Vervolgens aan de binnenkant van de vloeren vast kitten zodat de gaten afgedekt zijn. Er mag geen vingerbeknelling aanwezig zijn

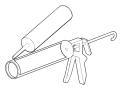
3 st. Vloerstrip	1 st. Kitspuit
<p>1</p> 	<p>2</p> 

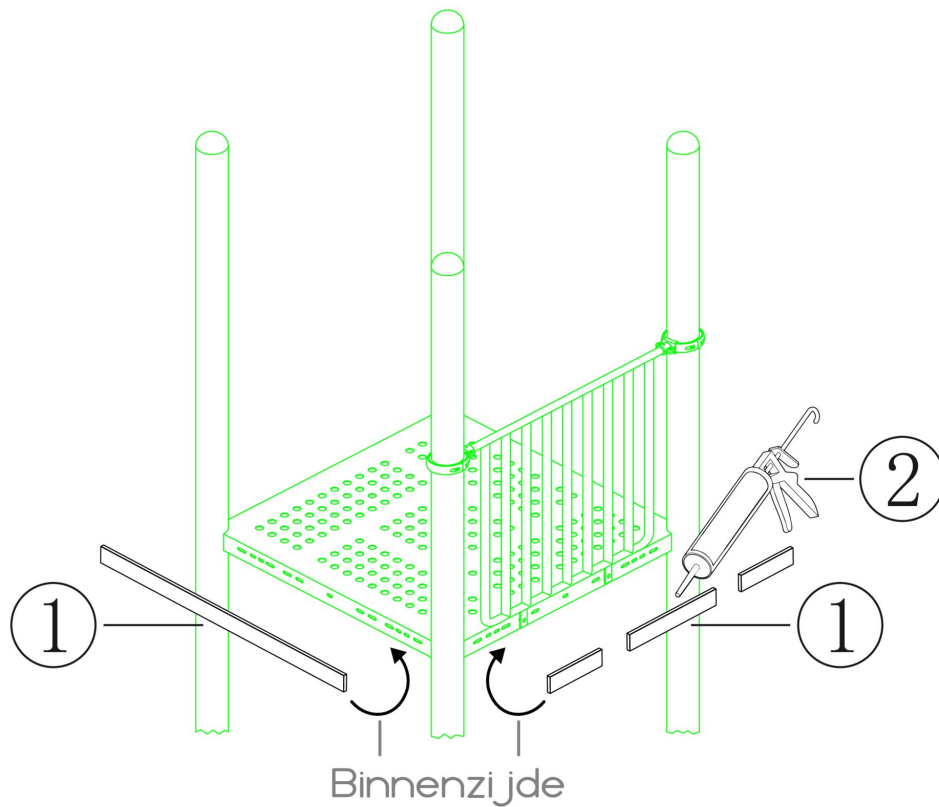

Bevestigings materiaal is per zakje verpakt en bovenstaande afbeelding zit in het zakje

# 5-Stappenbrug



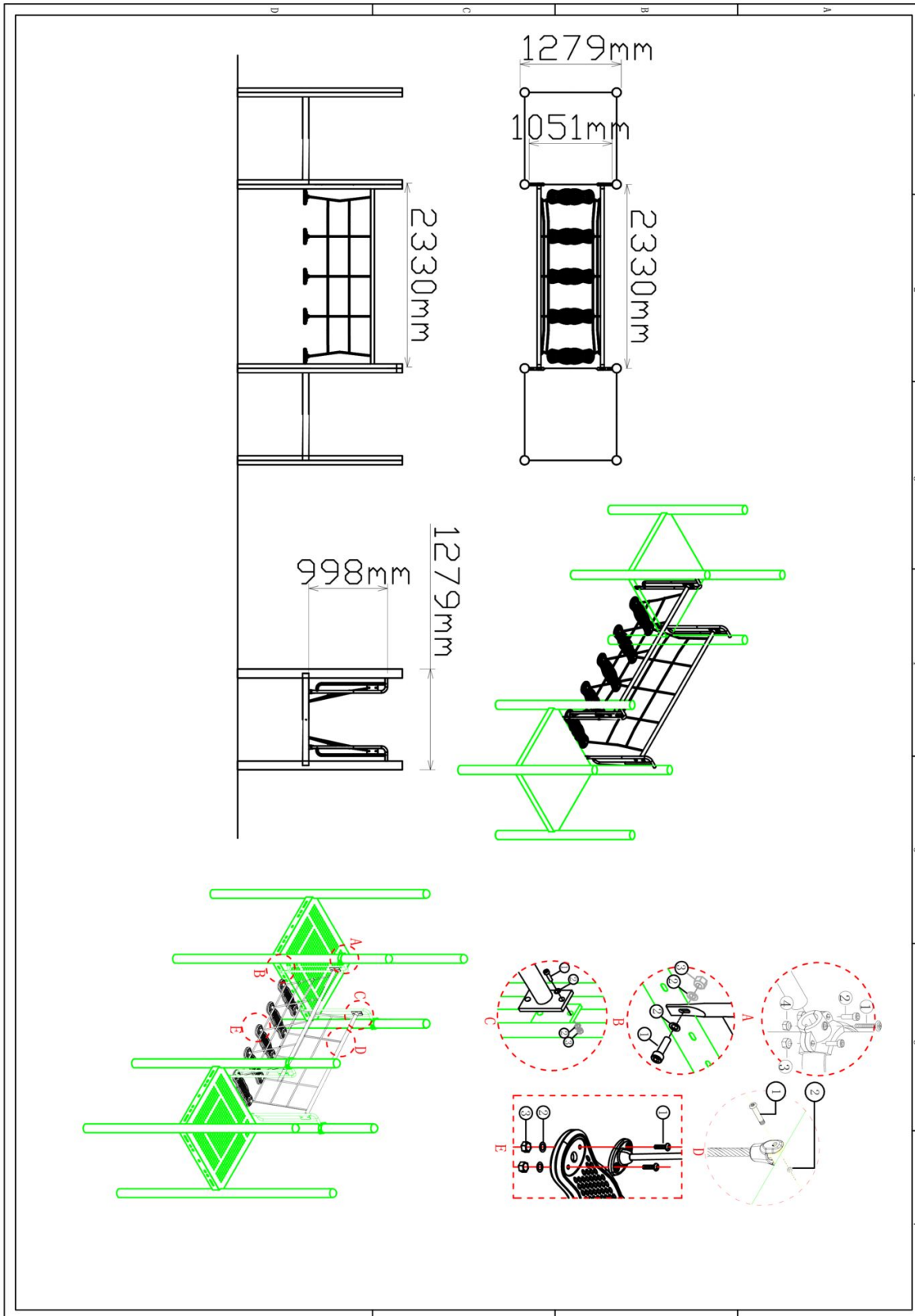

Hoofdafmetingen: 233x105x100cm

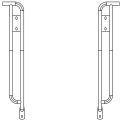

## 5-Stappenbrug

STAP 1 van 5

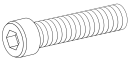
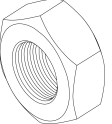
Omschrijving: Bevestiging tussen de hekjes van de brug en de staanders

2 st. PE stapbrug Handrail	4 st. Small clamp + ring	4 st. Kruiskop M6X65	8 st. Bout M8X20
		① 	② 
8 st. Lock Moer M10	4 st. Lock Moer M6		
③ 	④ 		

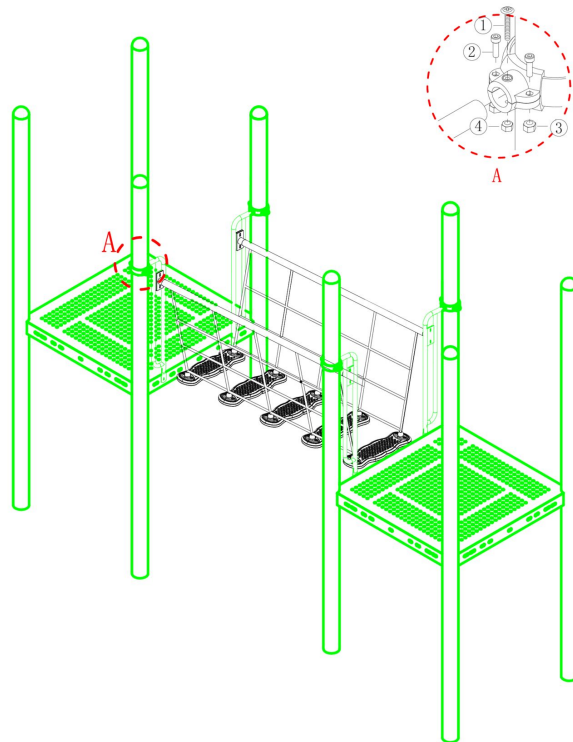

Bevestigings materiaal is per zakje verpakt en bovenstaande afbeelding zit in het zakje



## 5-Stappenbrug

STAP 2 van 5

Omschrijving: Bevestiging tussen de hekjes van de brug en de vloer

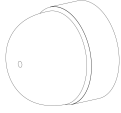
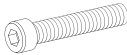
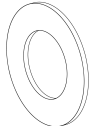
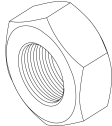
4 st. Afdekdop M10	4 st. Bout M10X25
	1 
8 st. Ring M10 (middel)	4 st. Lock Moer M10
2 	3 

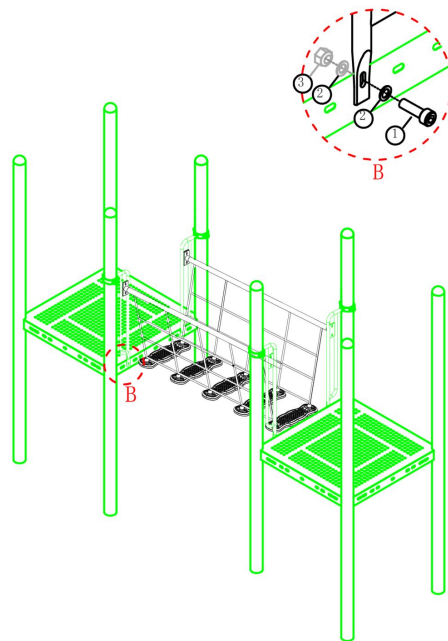

Bevestigings materiaal is per zakje verpakt en bovenstaande afbeelding zit in het zakje

## 5-Stappenbrug

STAP 3 van 5

Omschrijving: Bevestiging tussen de brugleuningen en de hekjes

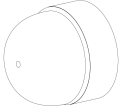
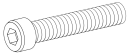
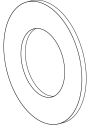
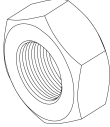
2 st. PE stapbrug leuning	8 st. Afdekdop M10		
			
8 st. Bout M10X25	16 st. Ring M10 (middel)	8 st. Lock Moer M10	
<p>1</p> 	<p>2</p> 	<p>3</p> 	

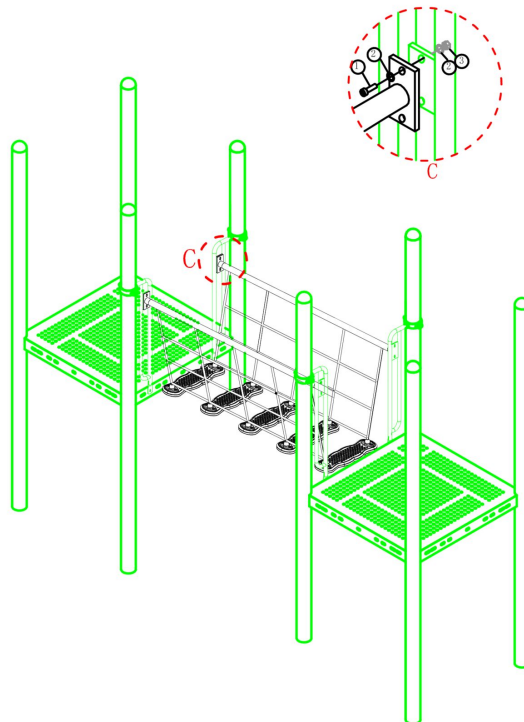

Bevestigings materiaal is per zakje verpakt en bovenstaande afbeelding zit in het zakje

## 5-Stappenbrug

STAP 4 van 5

Omschrijving: Bevestiging tussen de brugtouwen en de brugleuningen

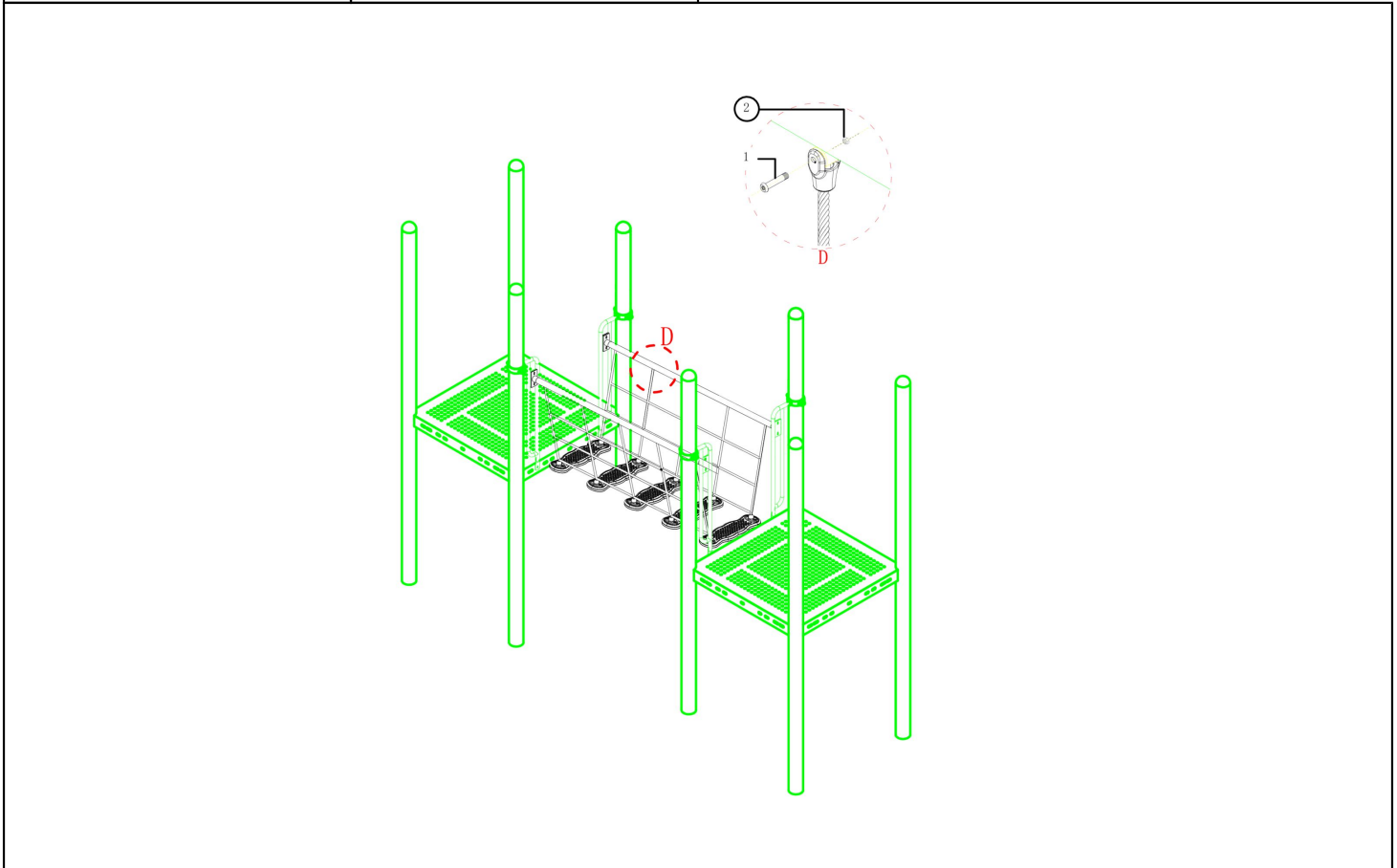
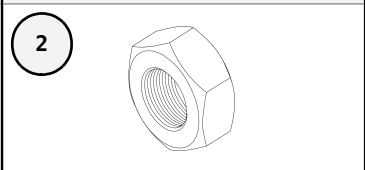
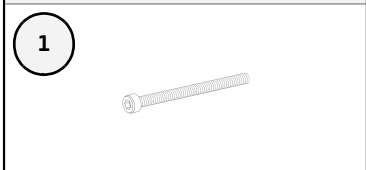
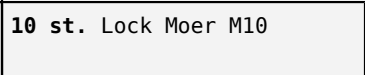
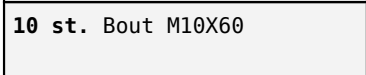
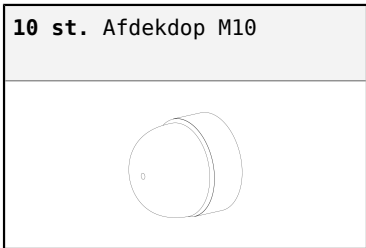



Bevestigings materiaal is per zakje verpakt en bovenstaande afbeelding zit in het zakje

## 5-Stappenbrug

STAP 5 van 5

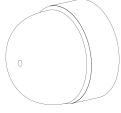
Omschrijving: Bevestiging tussen de stepjes en de brugtouwen

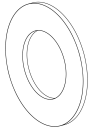
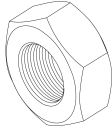
20 st. Afdekdop M10	20 st. Bout M10X60
	1 
20 st. Ring M10 (middel)	20 st. Lock Moer M10
2 	3 

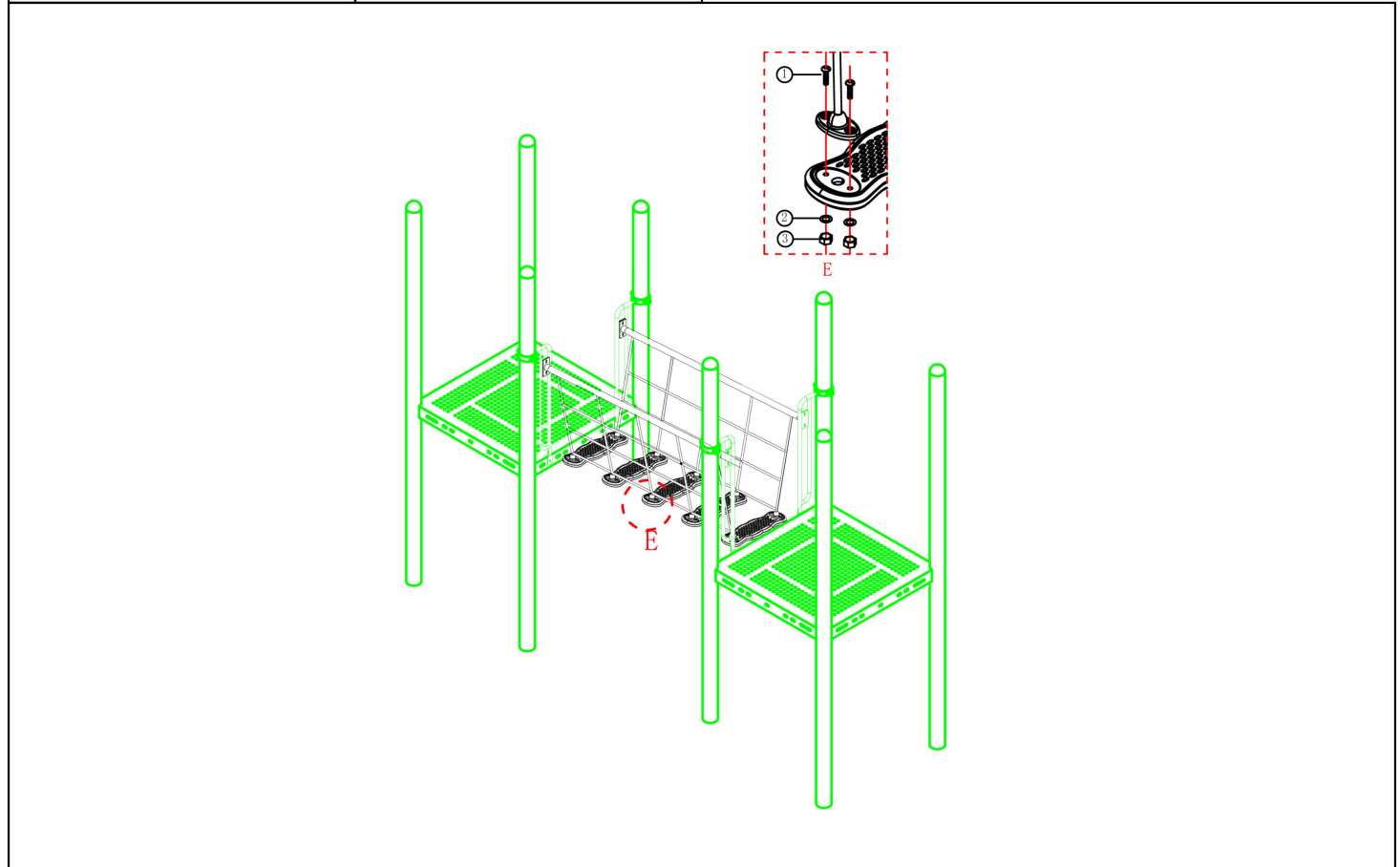

Bevestigings materiaal is per zakje verpakt en bovenstaande afbeelding zit in het zakje

# Hekje zonder bevestiging (boven)



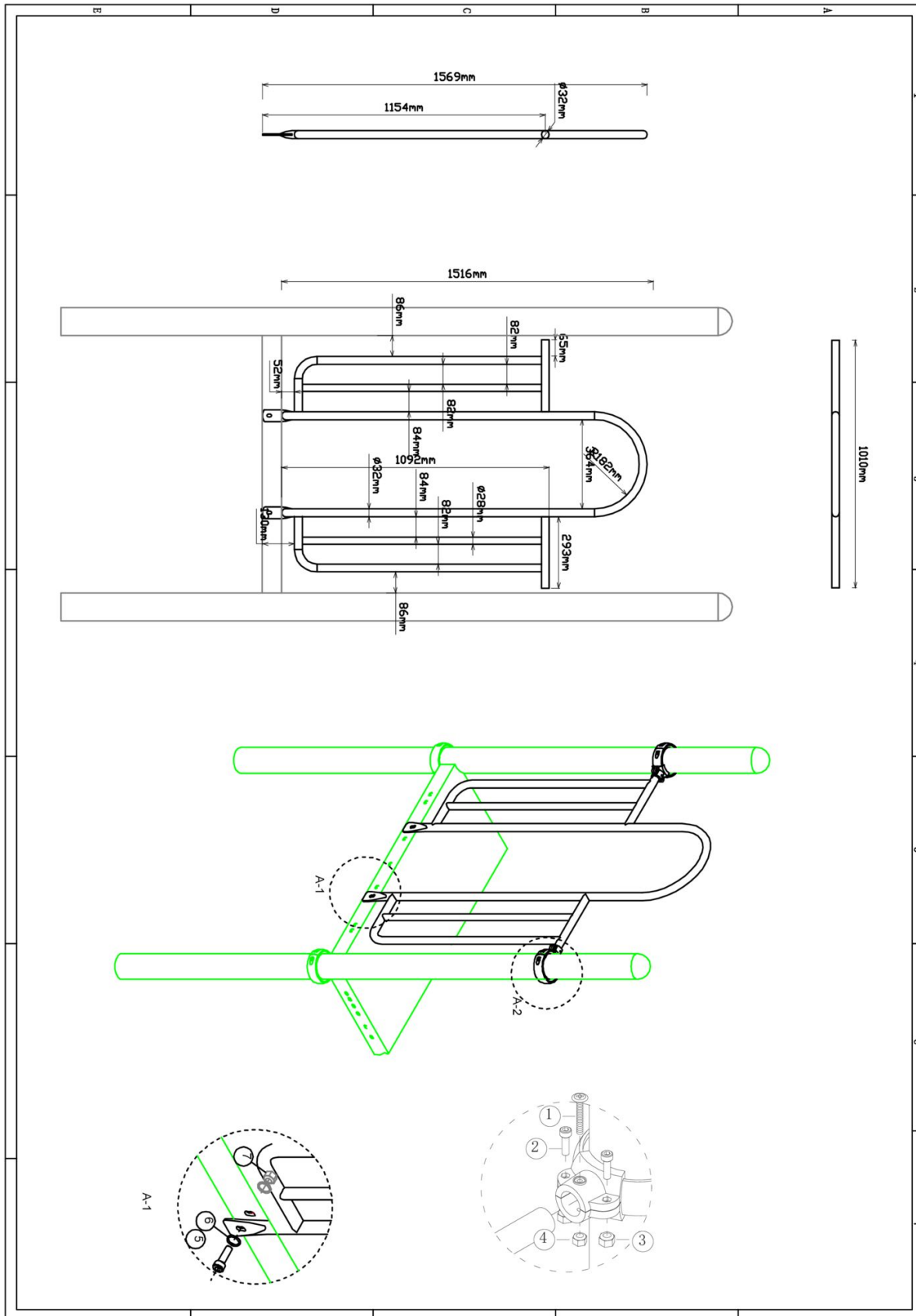



Hoofdafmetingen: 152x101cm

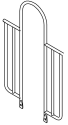

## Hekje zonder bevestiging (boven)

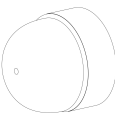
STAP 1 van 1

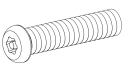
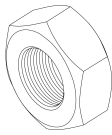
Omschrijving: Bevestiging van het hek tussen de vloer/staander

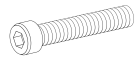
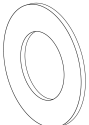
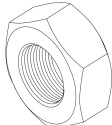
1 st. Hekje zonder bevestiging (boven)	2 st. Small clamp + ring	2 st. Afdekdop M10	2 st. Kruiskop M6X65
			
4 st. Torx M8X20	4 st. Lock Moer M8	2 st. Lock Moer M6	2 st. Bout M10X25
			
4 st. Ring M10 (middel)	2 st. Lock Moer M10		
			

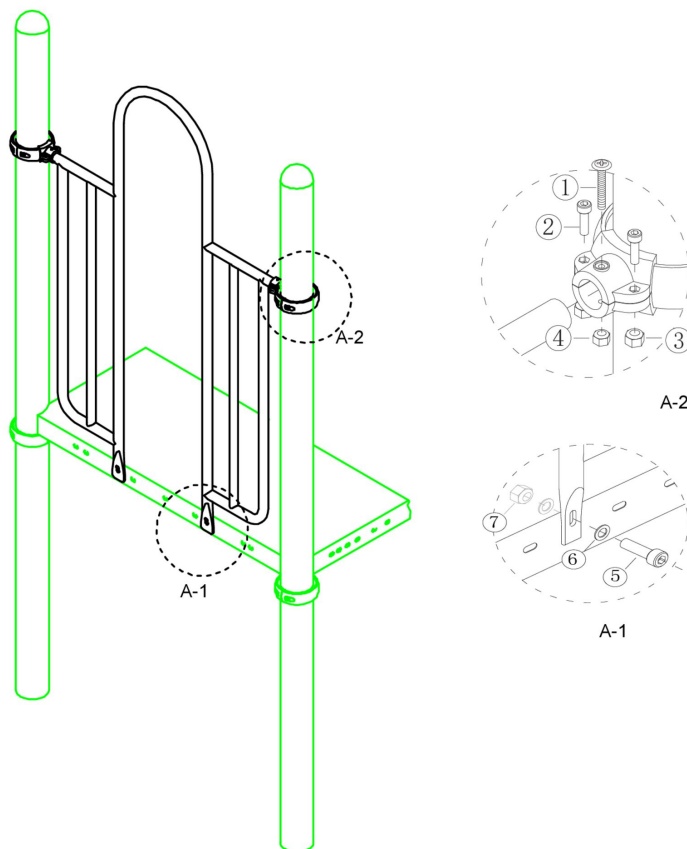

Bevestigings materiaal is per zakje verpakt en bovenstaande afbeelding zit in het zakje

### 150cm Arch climber

Hoofdafmetingen: 217x150x73cm

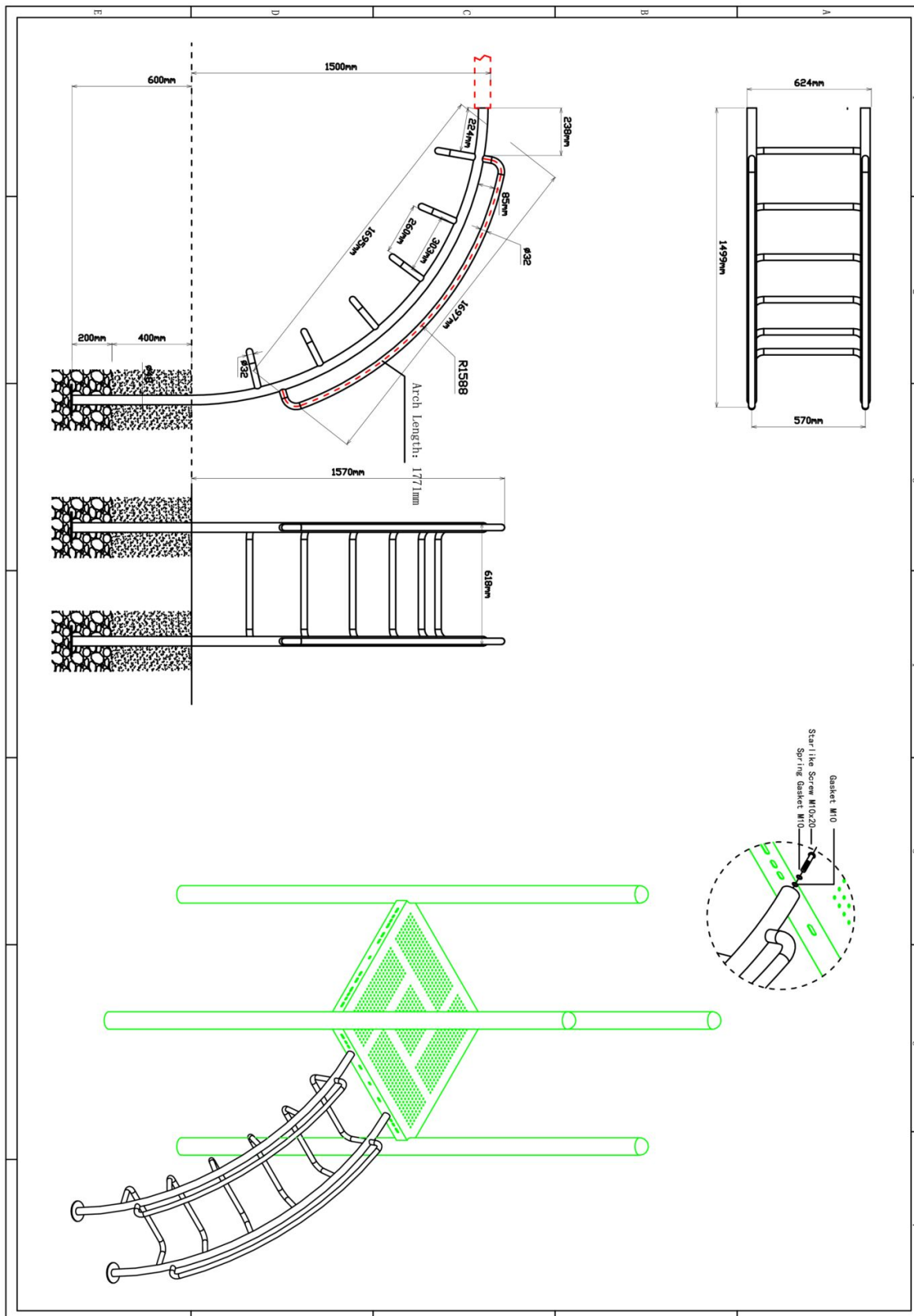

# 150cm Arch climber

STAP 1 van 1

Omschrijving: Bevestiging tussen vloer en Arch climber

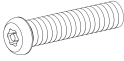
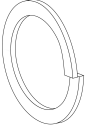
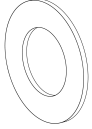
1 st. 150cm Arch climber	2 st. Torx M10X20	2 st. Veerring M10	2 st. Ring M10 (middel)
	<p>1</p> 	<p>2</p> 	<p>3</p> 

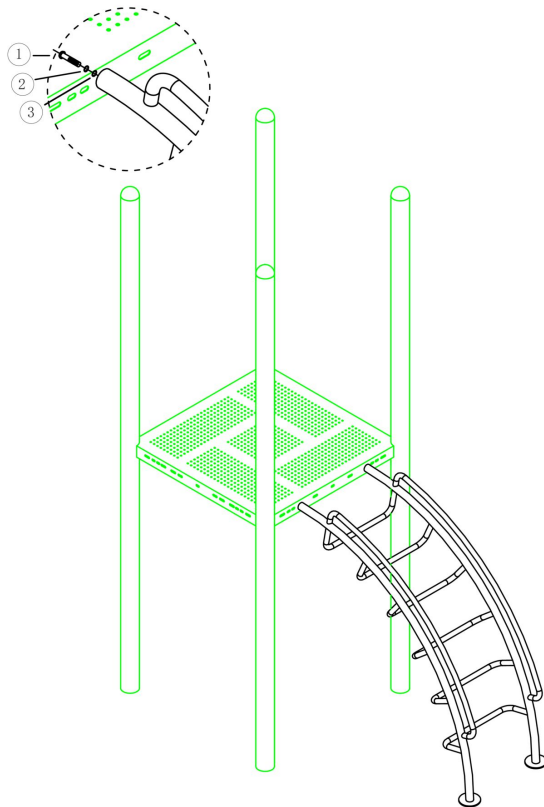

Bevestigings materiaal is per zakje verpakt en bovenstaande afbeelding zit in het zakje



# Hekje tbv glijstang



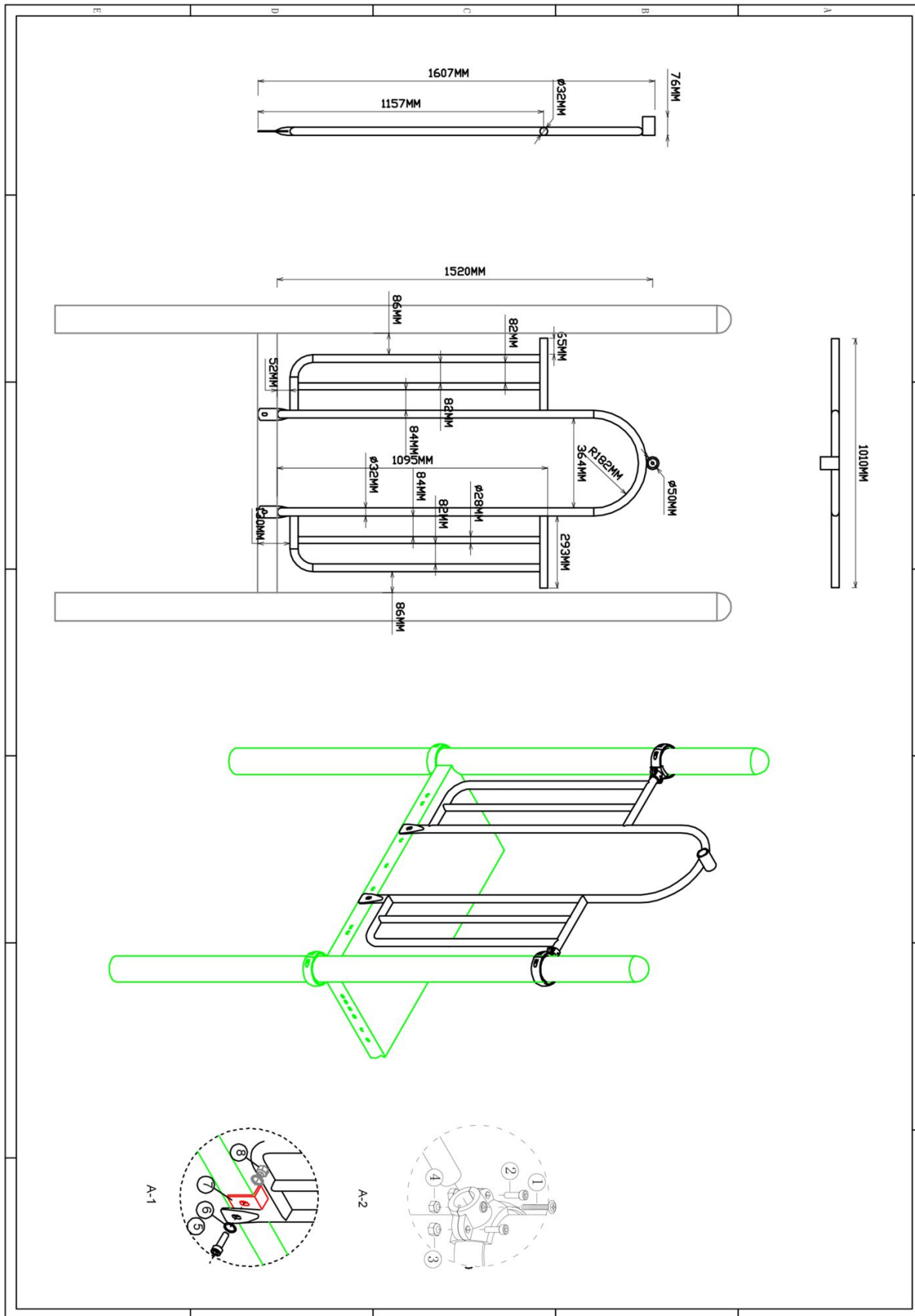





Hoofdafmetingen: 152x101cm

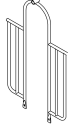

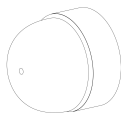
## Hekje tbv glijstang

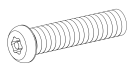
STAP 1 van 1

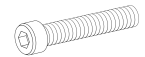
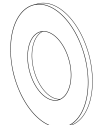
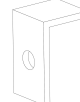
Omschrijving: Bevestiging van het hek tussen de vloer/staander

1 st. Hekje tbv glijstang	2 st. Small clamp + ring	2 st. Afdekdop M10	2 st. Kruiskop M6X65
			
4 st. Torx M8X20	4 st. Lock Moer M8	2 st. Lock Moer M6	2 st. Bout M10X25
			
4 st. Ring M10 (middel)	2 st. Hoekje	2 st. Lock Moer M10	
			

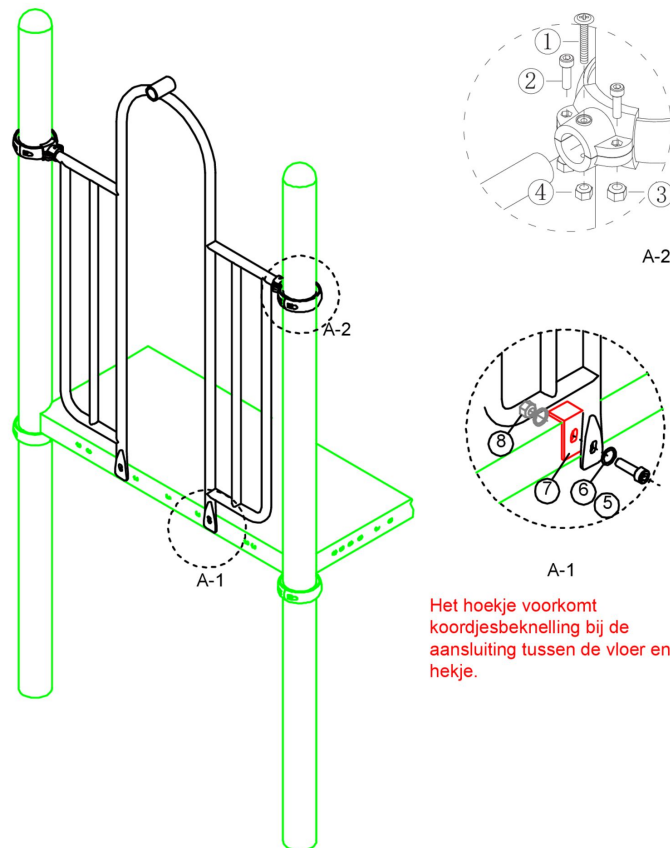

Het hoekje voorkomt koordjesbeknelling bij de aansluiting tussen de vloer en het hekje.

Bevestigings materiaal is per zakje verpakt en bovenstaande afbeelding zit in het zakje

## 150cm Glijstang

Hoofdafmetingen: 362x42cm

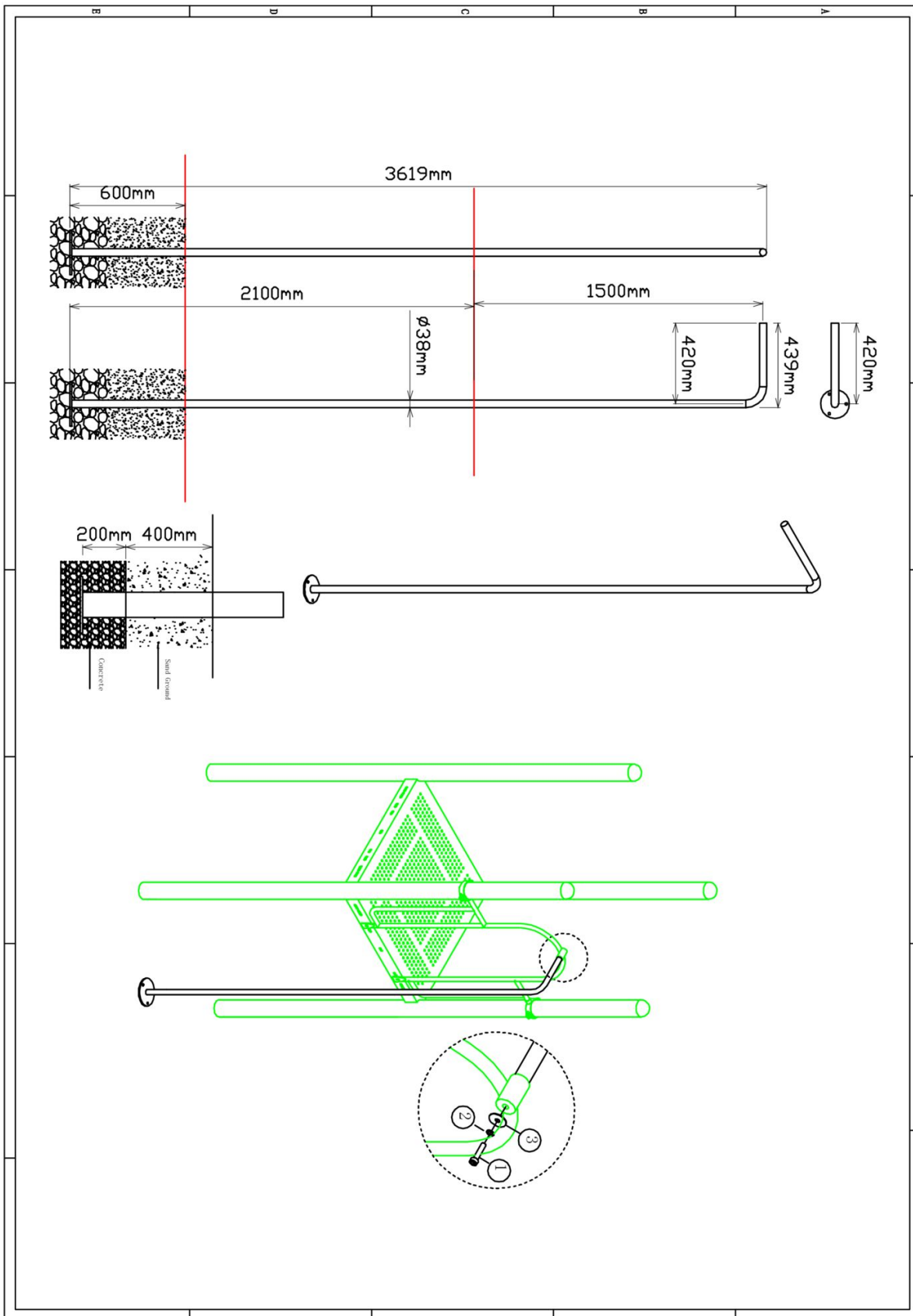

# 150cm Glijstang

STAP 1 van 1

Omschrijving: Bevestiging tussen de glijstang en het hek

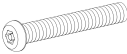
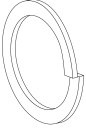
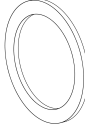
1 st. 150cm Glijstang	1 st. Torx M10X30	1 st. Veerring M10	1 st. Ring M10 (groot)
	<p>1</p> 	<p>2</p> 	<p>3</p> 

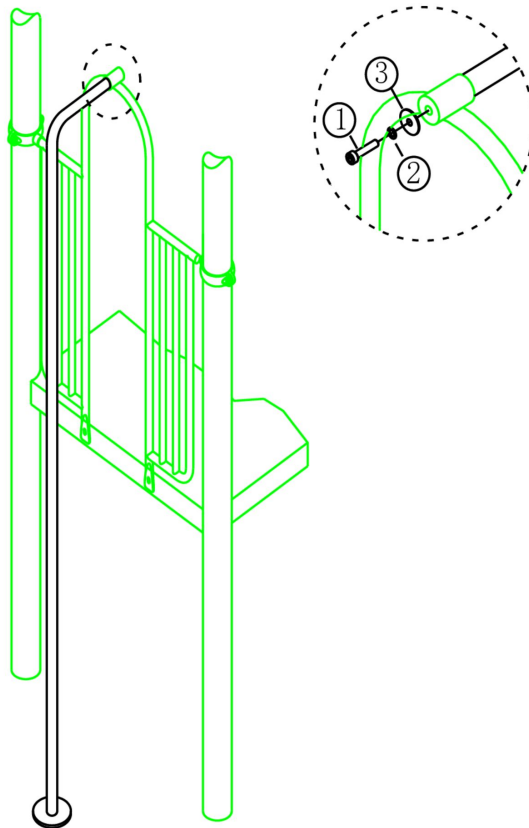









Bevestigings materiaal is per zakje verpakt en bovenstaande afbeelding zit in het zakje

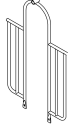

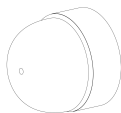
## Hekje tbv: B, Pod en Curly Climber

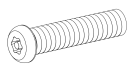
STAP 1 van 1

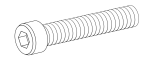
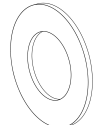
Omschrijving: Bevestiging van het hek tussen de vloer/staander

1 st. Hekje tbv: B, Pod en Curly Climber	2 st. Small clamp + ring	2 st. Afdekdop M10	2 st. Kruiskop M6X65
			
4 st. Torx M8X20	4 st. Lock Moer M8	2 st. Lock Moer M6	2 st. Bout M10X25
			
4 st. Ring M10 (middel)	2 st. Lock Moer M10		
			

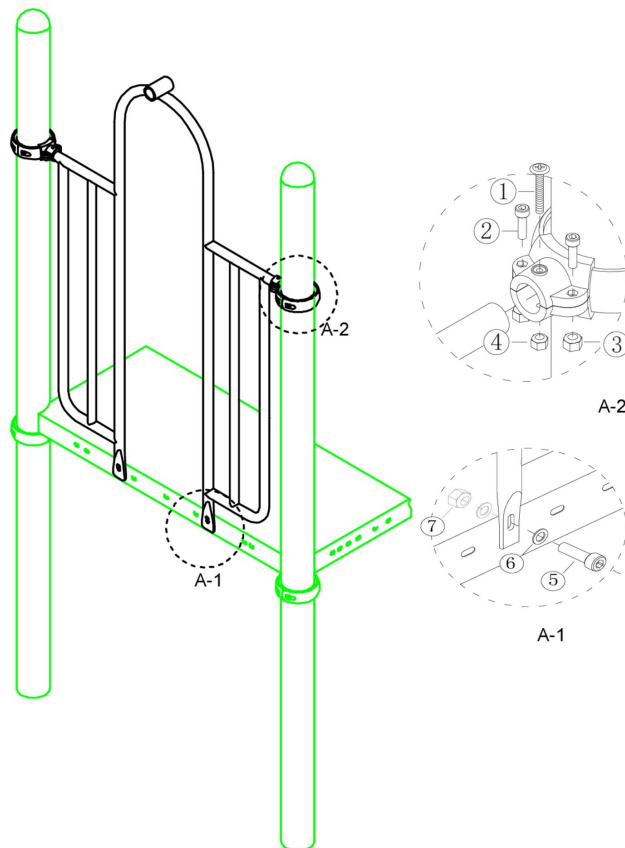

Bevestigings materiaal is per zakje verpakt en bovenstaande afbeelding zit in het zakje

**150cm B climber**

Hoofdafmetingen: 362x44cm

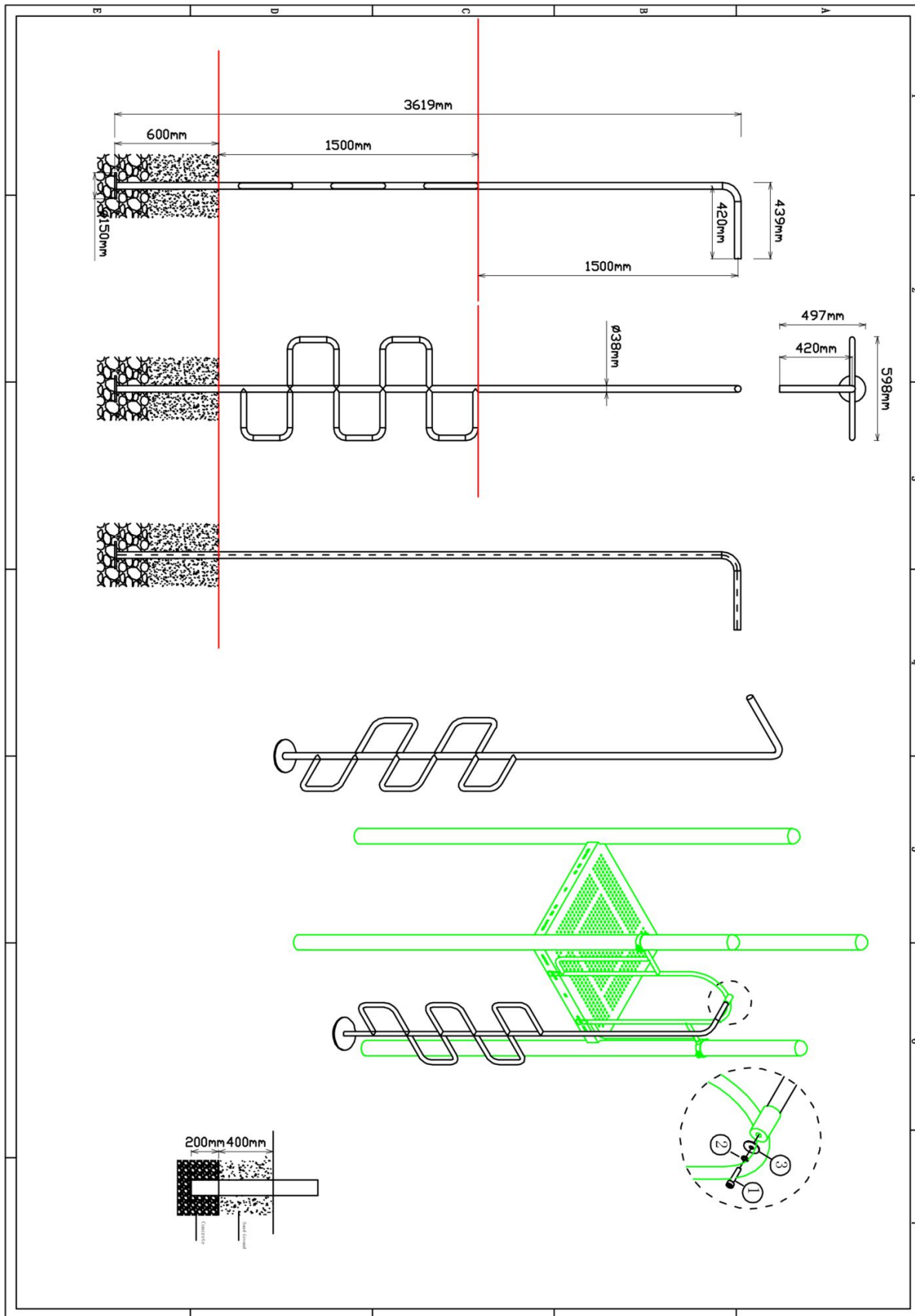

# 150cm B climber

STAP 1 van 1

Omschrijving: Bevestiging tussen B-climber en hek

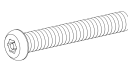
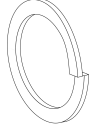
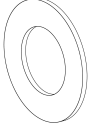
1 st. 150cm B climber	1 st. Torx M10X30	1 st. Veerring M10	1 st. Ring M10 (middel)
			

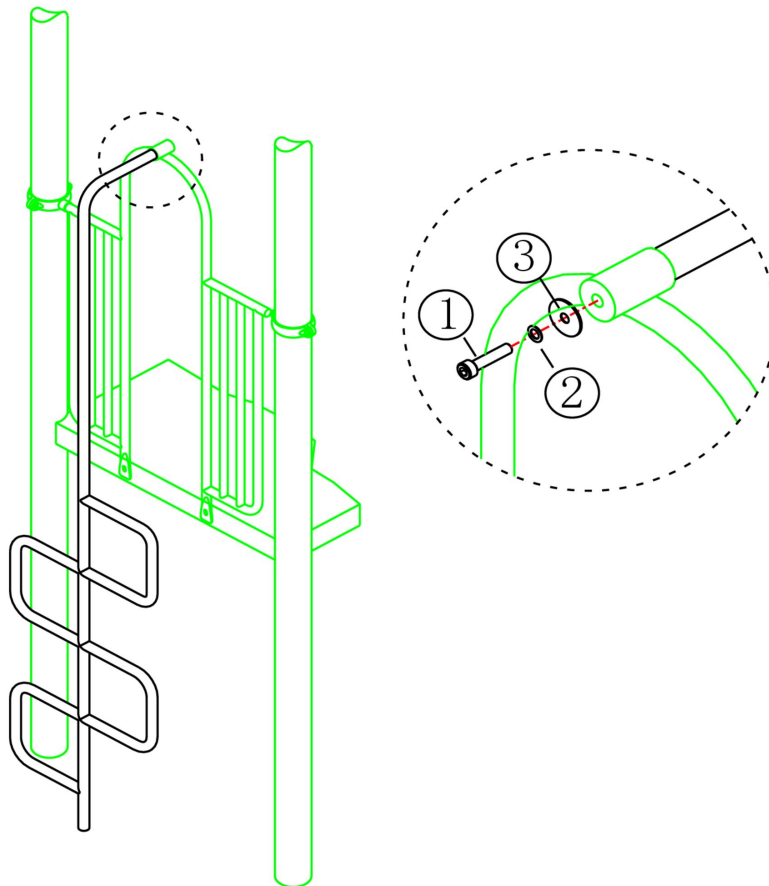

Bevestigings materiaal is per zakje verpakt en bovenstaande afbeelding zit in het zakje



# Hek voor RVS glijbaan



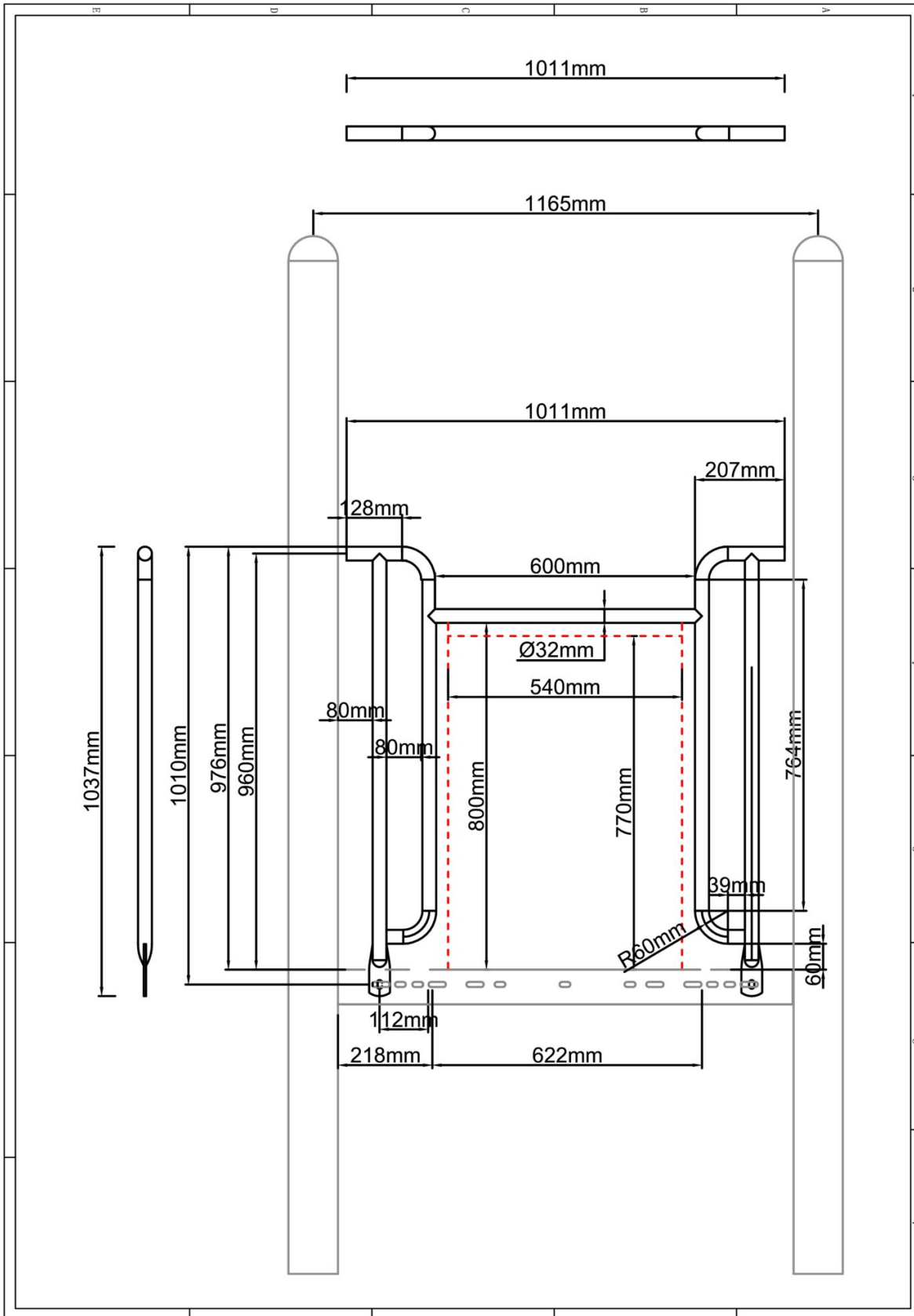

Hoofdafmetingen: 104x101cm

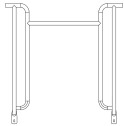

## Hek voor RVS glijbaan

STAP 1 van 1

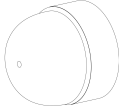
Omschrijving: Bevestiging tussen de vloer/staander en het hekje

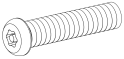
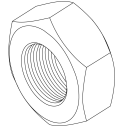
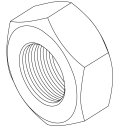
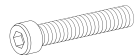
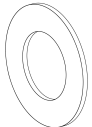
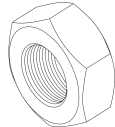
1 st. Hek voor RVS glijbaan	2 st. Small clamp + ring	2 st. Afdekdop M10	2 st. Kruiskop M6X65
			
4 st. Torx M8X20	4 st. Lock Moer M8	4 st. Lock Moer M6	2 st. Bout M10X25
			
4 st. Ring M10 (middel)	2 st. Lock Moer M10		
			

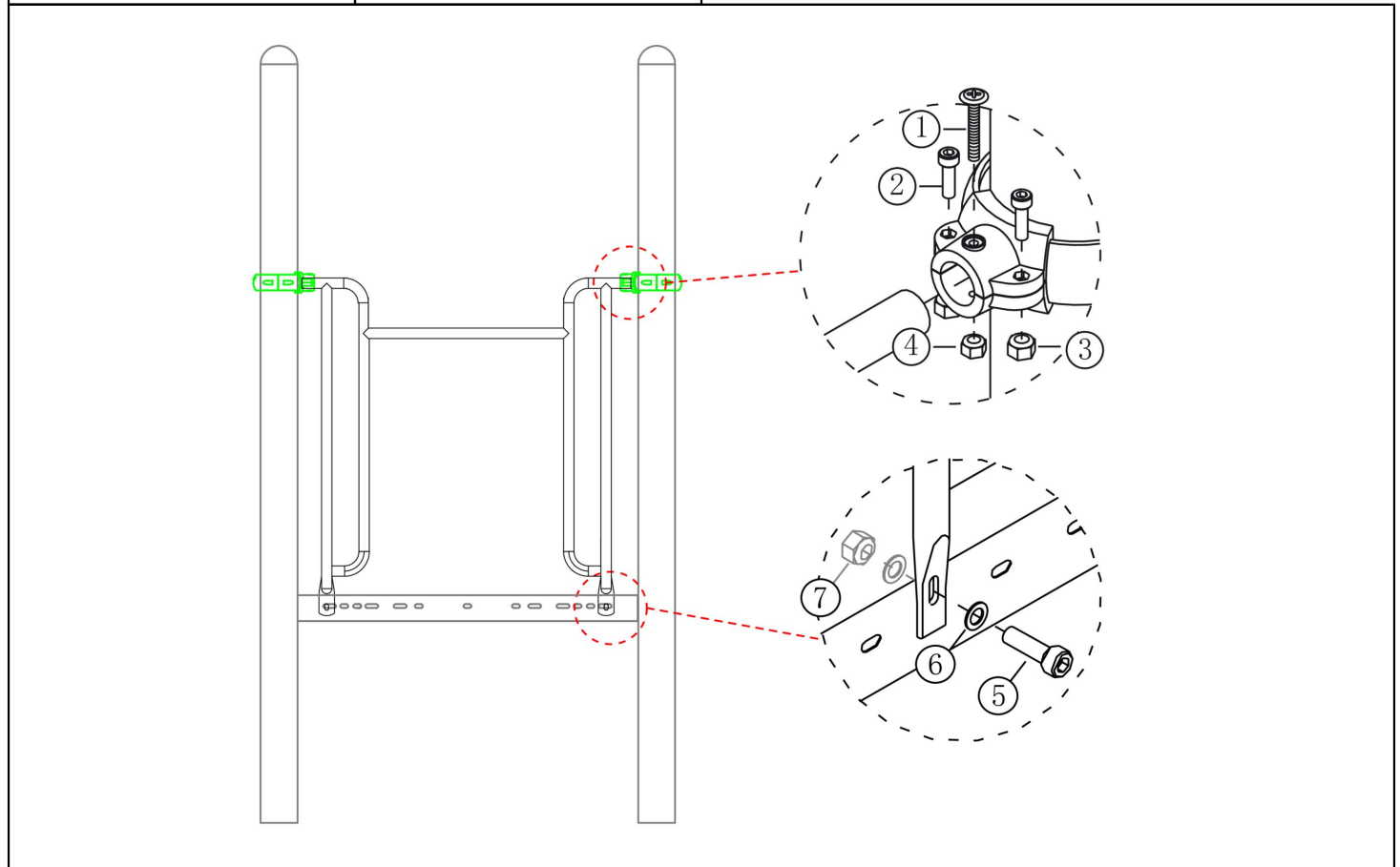

Bevestigings materiaal is per zakje verpakt en bovenstaande afbeelding zit in het zakje

### RVS Glijbaan 150cm

Hoofdafmetingen: 250x221cm

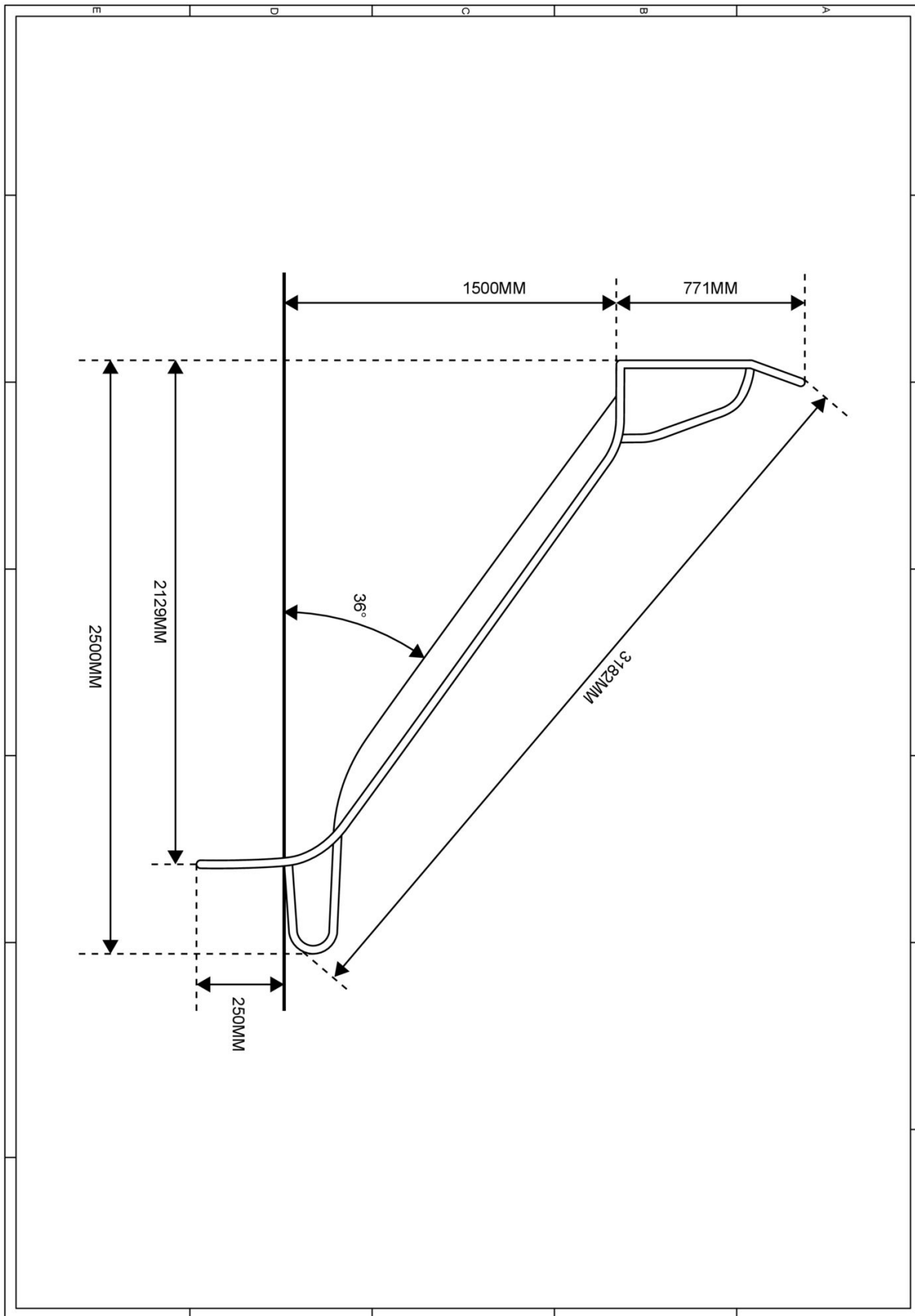

## RVS Glijbaan 150cm

STAP 1 van 2

Omschrijving: Bevestigings gaten in de vloer boren volgens schema

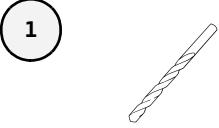
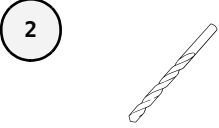
1 st. Boormachine	1 st. Boortje 6,5mm	1 st. Boortje 12,5mm
	<p>1</p> 	<p>2</p> 

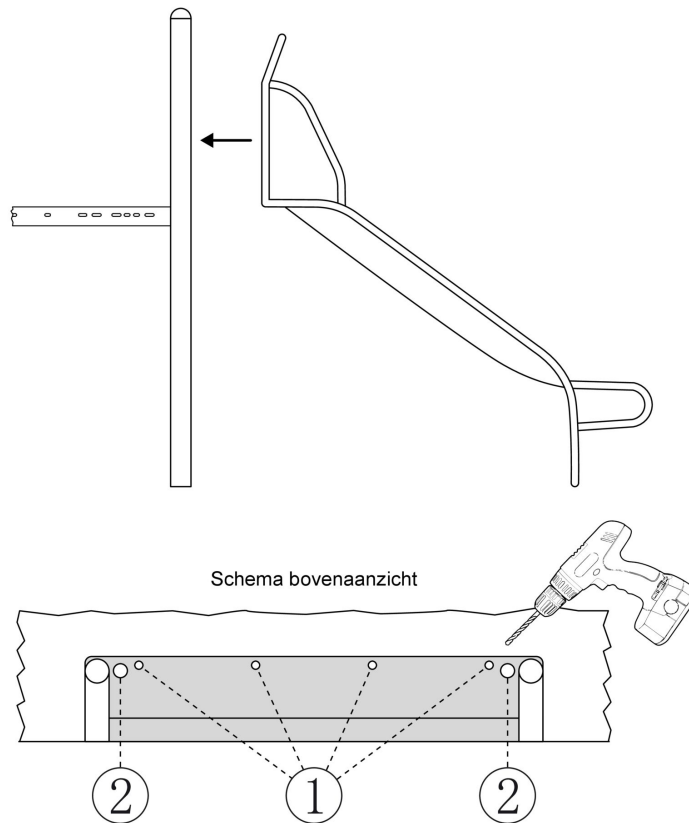

Bevestigings materiaal is per zakje verpakt en bovenstaande afbeelding zit in het zakje

# RVS Glijbaan 150cm

STAP 2 van 2

Omschrijving: Glijbaan op de vloer bevestigen met bijgeleverde montagepakket.

1 st. RVS Glijbaan 90cm			
4 st. Bout M6X20	4 st. Ring M6 (middel)	4 st. Lock Moer M6	4 st. Afdekdop M6
1	2	3	4
2 st. Slotbout M12X20	2 st. Ring M12 (middel)	2 st. Lock Moer M12	2 st. Afdekdop M12
5	6	7	8

Schema bovenaanzicht

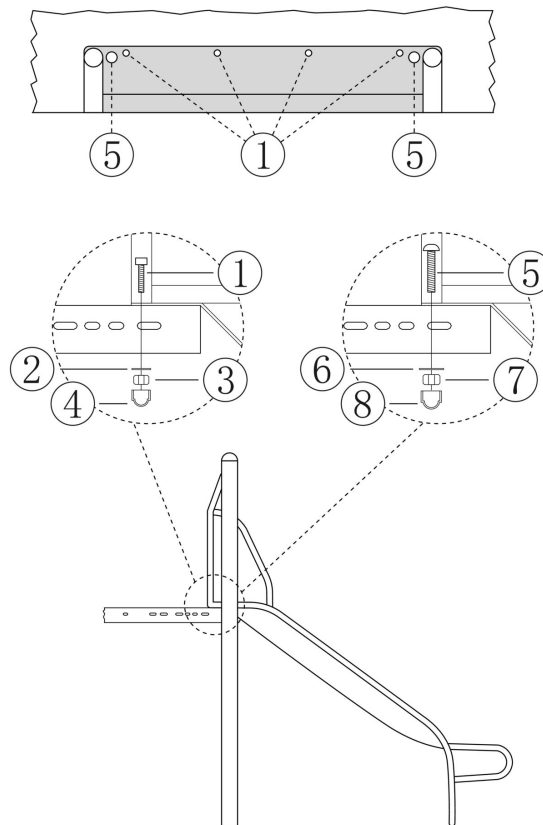

Bevestigings materiaal is per zakje verpakt en bovenstaande afbeelding zit in het zakje